

ROBEMAKER Sliding Door Track System

Wardrobe & Cupboard Doors - 40 kg Per Door

FEATURES:

- *Snap-Strip bottom track fixing - no unsightly screws
- *Maximum Door Load - 40kg per door
- *Smooth Running Adjustable Roller Sheave
- *Slimline Aluminium extrusions - available in Gloss White, White Birch and Clear Anodised.
- *Suits 2, 3 and 4 Door Openings
- *All Fixing Hardware included - screws are coloured to suit track
- *Reversible Headguide Channel - grooved face or smooth face
- *Suits door thickness 30mm (min.) to 40mm (max.)
- *Optional Jamb Channel now available in Gloss White & White Birch.

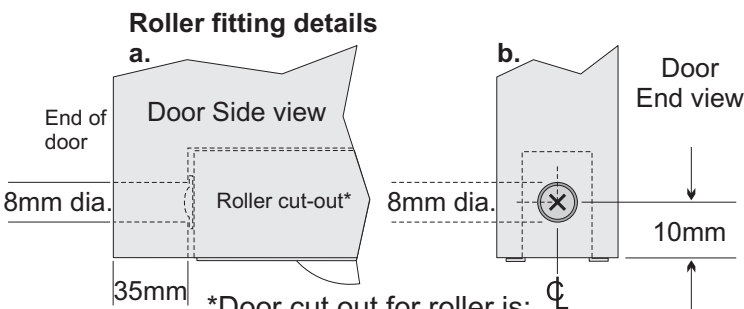
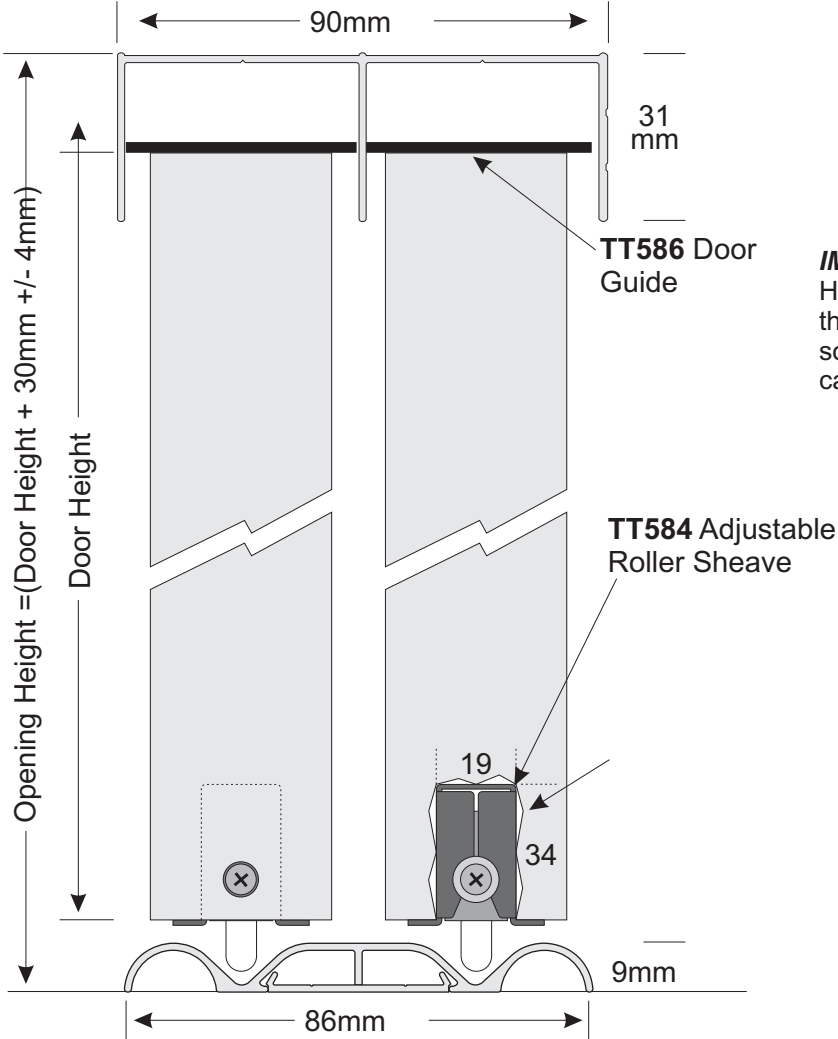

*Door cut out for roller is:
34mm H x 72mm W x 19mm T

Opening Width =

- 2 Door Set: 2 x Door Width less Nominal Overlap
- 3 Door Set: 3 x Door Width less 2 x Nominal Overlap
- 4 Door Set: 4 x Door Width less 2 x Nominal Overlap

TT580 Headguide Channel

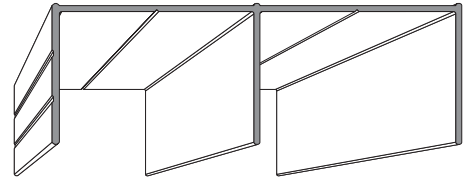

TT582 Double Track

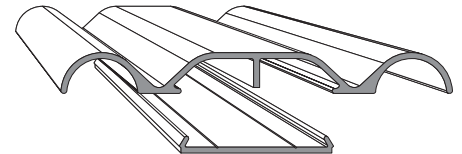

TT583 Snap Strip

IMPORTANT:

H.M. Cowdroy highly recommend that the Snap Strip be fixed to a solid surface and not directly on carpeted or other such surfaces.

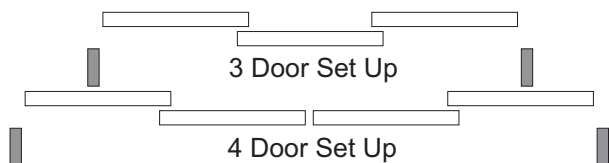
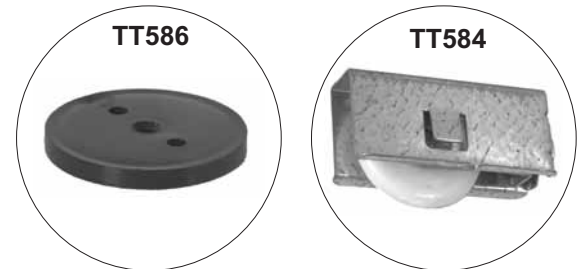
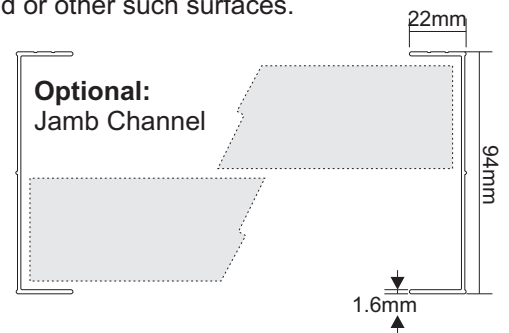

P580	Packaged Set for 2 doors 1620mm
P580	Packaged Set for 3 doors 2420mm
P580	Packaged Set for 4 doors 3240mm
P585	Components Pack for 1 Door
P588	Jamb Channel Set 2470mm
TT580	Headguide Channel 4880mm
TT582	Double Track 4880mm
TT583	Snap Strip 4880mm
TT584	Adjustable Roller Sheave
TT586	Door Guide
TT588	Jamb Channel 5000mm

