

Code EDPR60SS – 60cm Freestanding Dishwasher



12 PLACE SETTINGS

The 12-place settings option this dishwasher provides results in greater flexibility in what types of dishes and cutlery that can be washed.

SIMPLE ELECTRONIC PROGRAM SELECTOR

This model Euro dishwasher operates via electronic dial control by PC board. You can select your preferred program by using the electronic dial selector on the top right of the front panel.

FEATURES:

- + 12 place setting
- + Stainless design
- + 6 wash programs
 - + Rapid
 - + Heavy
 - + Normal
 - + 1 Hour Express
 - + Glass
 - + Intensive
- + 2 Level height adjustable top basket
- + Twin sliding cutlery baskets
- + Concealed Heating Element
- + Removable top cover (30mm)
- + Water consumption 12.0L
- + 3 star energy rating
- + 4 star water rating

6 WASH PROGRAMS WITH 1 HOUR EXPRESS

The EDPR60SS dishwasher provides you with the choice of 6 different wash programs to ensure you can select the type of wash which best suits whether it be after a small meal or large dinner party. The 1 hour express is a quick program with full washing performance, which saves the time and ensures your dishes come out clean and sparkling.

2 LEVEL HEIGHT ADJUSTMENT TOP BASKET

The adjustable top basket has the option of a high or low setting, Ensuring you can fit in those taller than normal dishes with ease.

WATER CONNECTION:

Cold water (as dishwasher has its own heating element)

NET WEIGHT: 39.0kg

GROSS WEIGHT: 45.0kg

CAPACITY: 12 Place Settings

NOISE LEVEL: 55 Decibel Rating

INSTALLATION: For all installation please refer qualified technician to our product manual.

INLET HOSE: 1.5m

ADJUSTABLE FEET: 20mm long

DRAIN HOSE: 1.5m long

ADJUSTABLE FEET: 20mm

*KEEPING YOUR DISHWASHER AS GOOD AS NEW

- **AFTER EVERY WASH** – leave the door slightly open to relieve the unit of any moisture and odours that can build up
- **NO SOLVENTS OR ABRASIVE CLEANING** – only use warm soapy water and a cloth to clean inside and outside the unit
- **WHEN NOT IN USE FOR A LONG TIME** – run a wash cycle with an empty dishwasher and then leave the door slightly open
- **MOVING THE APPLIANCE** – if this unit must be moved ensure it is kept in a vertical position.
- **UNIT SEALS** – one of the main causes of a smelly dishwasher is food being trapped in the seals. Regular cleaning with a damp sponge will assist in prevention.

PRODUCT DIMENSIONS

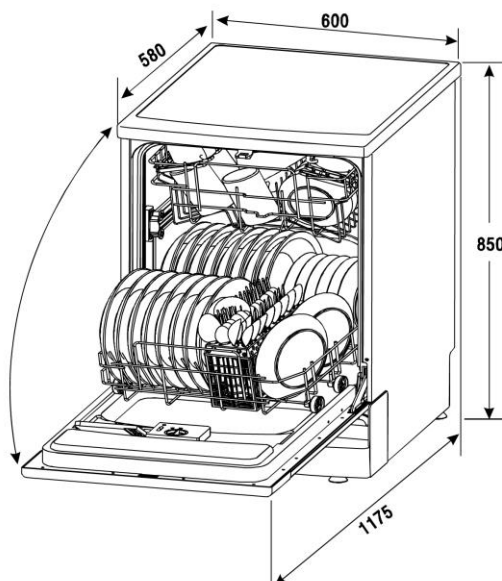

Energy rating: ★★★★★

Water rating: ★★★★★

