

# MODEL ADW5001X



## FREESTANDING DISHWASHER







### PRODUCT INFORMATION

- 12 place settings
- stainless steel colour

### FEATURES

- delay start option | 3-6-9-12 hours
- 49 dBA
- electronic control panel
- push-button functions: power, programs, delay function, child lock, start/pause
- 6 programs: intensive, heavy, ECO, 90-min, glass, rapid
- height-adjustable top basket
- flowmeter water sensor
- extra drying
- strong wash
- grey basket
- VDE hose



PROGRAM	TYPE	CYCLE	DETERGENT pre/main gr	DURATION minutes	ENERGY kW/hr	WATER litres	RINSE AID
intensive 	for heaviest soiled loads, eg pots, pans, casserole dishes, and dried-on food	prewash 50°C prewash wash 65°C rinse/rinse 65°C drying	5/25	140	1.7	23	★
heavy 	for heavily soiled loads, eg pots, plates, glasses and lightly soiled pans – standard daily cycle	prewash 50°C wash 50°C rinse/rinse 70°C drying	5/25	160	1.3	15	★
ECO	for heavily soiled loads such as pots, plates & glasses and lightly soiled pans; standard daily cycle	prewash   wash 45°C rinse 45°C drying	5/28.75g (1 piece)	195	0.64	11.8	★
90-minute 	for lightly soiled plates and pans that need a quick wash	wash 65°C rinse   rinse 65°C drying	33.75g (1 piece)	90	1.15	13	★
glass 	for lightly soiled crockery and glass	pre-wash   wash 40°C rinse   rinse 60°C drying	5/28.75g (1 piece)	130	0.75	15	★
rapid 	a shorter wash for lightly soiled loads that do not need drying	wash 40°C rinse/rinse 45°C	20	30	0.5	12	

EAN 9347777001412

AR221118

### DISCLAIMER

Eurolinx PTY LTD, is continually seeking ways to improve the design specifications, aesthetics and production techniques of its products. As a result alterations to our products and designs take place continually. Whilst every effort is made to produce information and literature that is up to date, this brochure should not be regarded as an infallible guide to the current specifications, nor does it constitute an offer for the sale of any particular product. Product dimensions indicated in our literature is indicative only. Actual product only should be used to define dimension cut outs. Distributors, and retailers are not agents of Eurolinx and are not authorized to bind Eurolinx by any express or implied undertaking or representation.

**FOLLOW US ON:**  [instagram.com/artusi\\_appliances](https://www.instagram.com/artusi_appliances)

 [www.linkedin.com/company/eurolinx-pty-ltd-t-a-llve/](https://www.linkedin.com/company/eurolinx-pty-ltd-t-a-llve/)

Australia National Telephone Number 1300 (694 583) New Zealand Telephone Number 64 3 344 5913  
Artusi showroom hours: Tuesday to Friday - 9am-5pm, Saturday - 10am-4pm, Sunday and Monday - closed  
\* Melbourne showroom hours: Tuesday to Saturday - 10am-4pm

[artusi.com.au](http://artusi.com.au)

**NSW & ACT (Head Office)**  
48-50 Moore Street  
Leichhardt  
F 02 8569 4699

**VIC & SA**  
1211 Toorak Road  
Camberwell  
F 03 9809 2155

**QLD**  
1/42 Cavendish Road  
Coorparoo  
F 07 3397 0850

**WA & NT**  
Unit 10/55 Howe Street  
Osborne Park  
F 08 9201 9188

**TAS**  
3 Pear Avenue  
Derwent Park  
F 03 6272 7386

**New Zealand**  
PO Box 11,160  
Sockburn Christchurch  
F 03 344 5906

# MODEL ADW5001X



FREESTANDING DISHWASHER



## TECHNICAL DIAGRAM

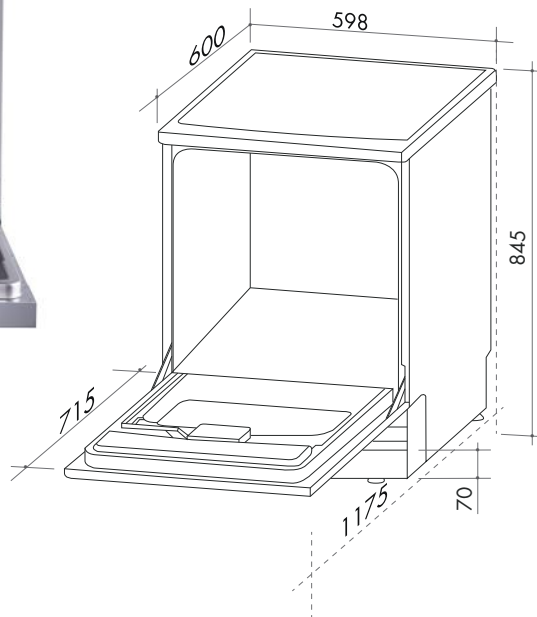

1 cups glasses 2 saucers  
3 glasses 4 dessert plates

The upper basket is designed to hold more delicate and lighter dishware such as glasses, coffee and tea cups and saucers, as well as small plates and bowls and shallow pans (provided they are not too soiled).

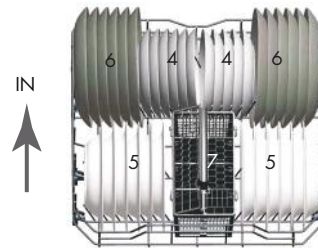

4 dessert dishes dinner plates 5 soup plates  
6 dinner plates 7 cutlery

It is suggested that large items, and items that are most difficult to clean, are placed in the lower basket — eg pots, pans, lids, serving dishes etc. It is preferable to place serving dishes and lids on the side of the racks to avoid blocking rotation of the top spray arm.

NB: drawings are not to scale — they are to be used for detailed installation instructions, please refer to user guide.

**EAN 9347777001412**

AR221118

### DISCLAIMER

Eurolinx PTY LTD, is continually seeking ways to improve the design specifications, aesthetics and production techniques of its products. As a result alterations to our products and designs take place continually. Whilst every effort is made to produce information and literature that is up to date, this brochure should not be regarded as an infallible guide to the current specifications, nor does it constitute an offer for the sale of any particular product. Product dimensions indicated in our literature is indicative only. Actual product only should be used to define dimension cut outs. Distributors, and retailers are not agents of Eurolinx and are not authorized to bind Eurolinx by any express or implied undertaking or representation.

ADW5001X Freestanding dishwasher

Size mm 598Wx600Dx845H

10 AMP GPO; standard 3-pin plug and cord 240V

**FOLLOW US ON:**  [instagram.com/artusi\\_appliances](https://www.instagram.com/artusi_appliances)

 [www.linkedin.com/company/eurolinx-pty-ltd-t-a-lv/](https://www.linkedin.com/company/eurolinx-pty-ltd-t-a-lv/)

Australia National Telephone Number 1300 (694 583) New Zealand Telephone Number 64 3 344 5913  
Artusi showroom hours: Tuesday to Friday - 9am-5pm, Saturday - 10am-4pm, Sunday and Monday - closed  
\* Melbourne showroom hours: Tuesday to Saturday - 10am-4pm

[artusi.com.au](http://artusi.com.au)

**NSW & ACT (Head Office)**  
48-50 Moore Street  
Leichhardt  
F 02 8569 4699

**VIC & SA**  
1211 Toorak Road  
Camberwell  
F 03 9809 2155

**QLD**  
1/42 Cavendish Road  
Coorparoo  
F 07 3397 0850

**WA & NT**  
Unit 10/55 Howe Street  
Osborne Park  
F 08 9201 9188

**TAS**  
3 Pear Avenue  
Derwent Park  
P 03 6272 7386

**New Zealand**  
PO Box 11,160  
Sockburn Christchurch  
F 03 344 5906