

DWD XP Magic Sorto



Drawer organizing.



For example: DWD XP Agantis with Magic Sorto

- Modular expandable system
- Individual removable components,
- Food safe, hygienically approved
- Trays made of stainless steel

Standard colours

-  alu-metallic
-  stainless steel look
-  champagne

Special colours (on request)

-  white

Magic Sorto Set



	Nennlänge/Set	Artikel-Nr. alu-metallic	Artikel-Nr. Edelstahl	Artikel-Nr. Champagne
1	400 B3	12030.400.17	-	-
2	400 B4	12040.400.17	-	-
3	450 B3	12030.450.17	-	-
4	450 B4	12040.450.17	-	-
5	500 B3	12030.500.17	12030.500.40	12030.500.41
6	500 B4	12040.500.17	12040.500.40	12040.500.41
7	500 B4S	12046.500.17	12046.500.40	12046.500.41
8	550 B3	12030.550.17	-	-
9	550 B4	12040.550.17	-	-
	VPE/Verpackungseinheit	VPE 1	VPE 1	VPE 1

VPE 1 = 1 Set im Karton

Divider Support



Nominal length	Item No. alu-metallic
500	12101.500.17
PU/package unit	PU 25

PU 25 = 25 pcs. loose in carton

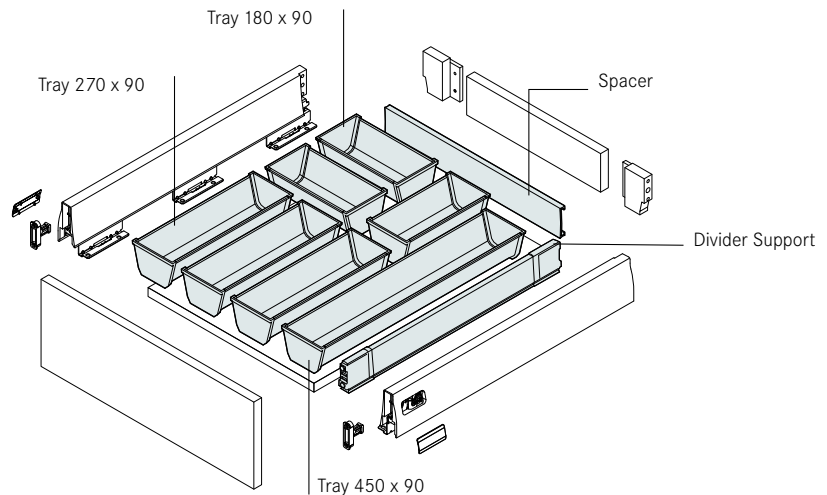

Assembly variations

1 Magic Sorto Set NL 400 B3



NL 400 and cabinet widths from 450 mm or more.

Consisting of:

- 2 Sorto trays 270 x 90 mm
- 3 Sorto trays 180 x 90 mm
- 1 Spacer 270 mm
- 1 Divider Support

2 Magic Sorto Set NL 400 B4



NL 400 and cabinet widths from 600 mm or more.

Consisting of:

- 4 Sorto trays 270 x 90 mm
- 2 Sorto trays 180 x 90 mm
- 2 Spacer 180 mm
- 1 Divider Support

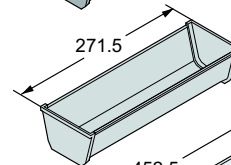
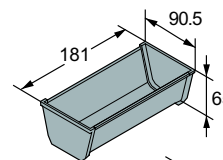

3 Magic Sorto Set NL 450 B3



NL 450 and cabinet widths from 450 mm or more.

Consisting of:

- 2 Sorto trays 270 x 90 mm
- 3 Sorto trays 180 x 90 mm
- 3 Compression trays 60 mm
- 1 Divider Support

4 Magic Sorto Set NL 450 B4

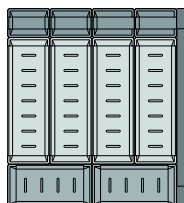

NL 450 and cabinet widths from 600 mm or more.

Consisting of:

- 4 Sorto trays 270 x 90 mm
- 2 Sorto trays 180 x 90 mm
- 4 Compression trays 60 mm
- 1 Divider Support

5 Magic Sorto Set NL 500 B3



NL 500 and cabinet widths from 450 mm or more.

Consisting of:

- 3 Sorto trays 270 x 90 mm
- 3 Sorto trays 180 x 90 mm
- 1 Spacer 270 mm
- 1 Divider Support

6 Magic Sorto Set NL 500 B4



NL 500 and cabinet widths from 600 mm or more.

Consisting of:

- 4 Sorto trays 270 x 90 mm
- 4 Sorto trays 180 x 90 mm
- 2 Spacer 180 mm
- 1 Divider Support

7 Magic Sorto Set NL 500 B4S



NL 500 and cabinet widths from 600 mm or more.

Consisting of:

- 1 Sorto tray 450 x 90 mm
- 3 Sorto trays 270 x 90 mm
- 3 Sorto trays 180 x 90 mm
- 2 Spacer 180 mm
- 1 Divider Support

8 Magic Sorto Set NL 550 B3



NL 550 and cabinet widths from 450 mm or more.

Consisting of:

- 3 Sorto trays 270 x 90 mm
- 3 Sorto trays 180 x 90 mm
- 3 Compression trays 70 mm
- 1 Divider Support

9 Magic Sorto Set NL 550 B4



NL 550 and cabinet widths from 600 mm or more.

Consisting of:

- 4 Sorto trays 270 x 90 mm
- 4 Sorto trays 180 x 90 mm
- 4 Compression trays 70 mm
- 1 Divider Support

Measurements

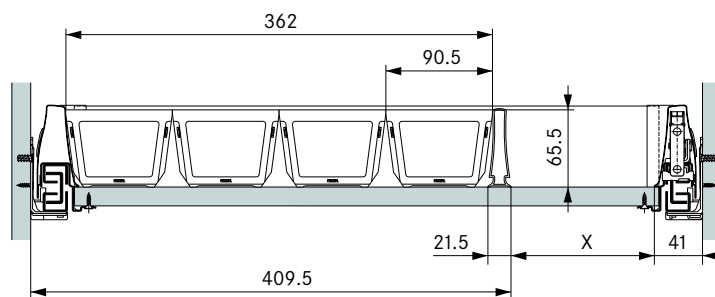
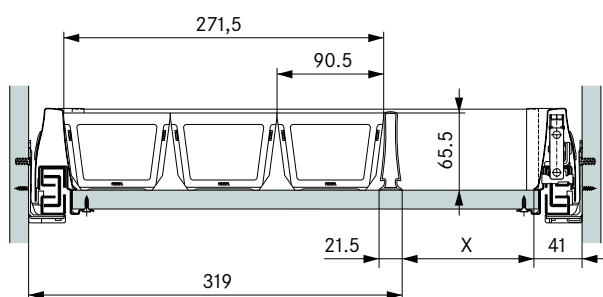

All measurements in millimeters.